

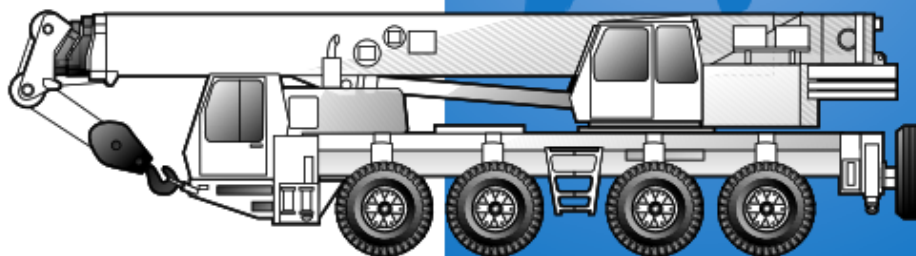

GMK 4085B



All Terrain Hydraulic Crane

WARNING!

The provided information is for reference purposes only and should not be used to operate the crane. The crane's specific operator's manual should be consulted and understood prior to crane operation.

Dimensions

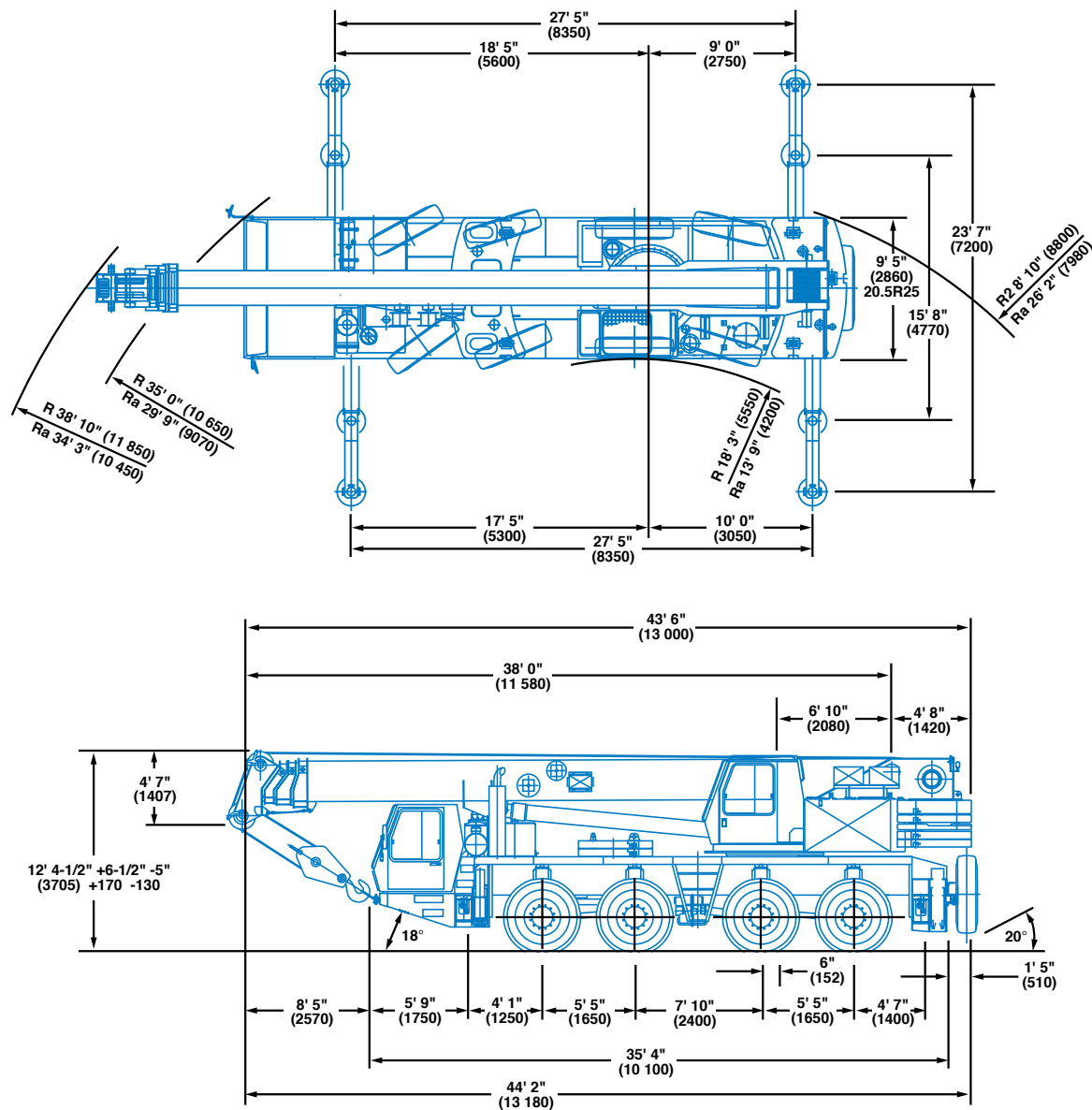

Note: () Reference dimensions in mm

Model GMK4085B equipped with:

8 x 6 x 8 drive/steer, 20.5 R25 tires; 4,000 lbs.

removable counterweight, brackets for S/A, oil cooler
(Must be roaded with 4,000 lb. counterweight plate for correct weight distribution)

	Front (2)	Rear (2)	Total
8 x 6 x 8 drive/steer, 20.5 R25 tires; 4,000 lbs. removable counterweight, brackets for S/A, oil cooler (Must be roaded with 4,000 lb. counterweight plate for correct weight distribution)	52,006 lbs. (2 x 26,003)	37,624 lbs. (2 x 18,812)	89,630 lbs.

Weights for accessory equipment:

1. Lattice extension w/brackets (33 - 53 ft.) stowed on boom	+ 3,781	- 915	+ 2,866
2. Auxiliary hoist with cable	- 1,940	+ 4,585	+ 2,645
3. 16.00R25 tires in lieu of 20.5R25 tires	- 370	- 370	- 740
4. 14.00R25 tires in lieu of 20.5R25 tires	- 900	- 900	- 1,800
5. Spare tire (on rear of carrier w/carry bracket)			
14.00R25	- 415	+ 1,000	+ 585
16.00R25	- 515	+ 1,230	+ 715
20.5R25	- 590	+ 1,400	+ 810
6. Outrigger floats stowed	+ 170	+ 180	+ 350
7. 8 x 8 x 8 drive/steer	+ 215	+ 820	+ 1,035
8. 45 - ton hook block on carrier	+ 1,850	- 360	+ 1,490
9. 45 - ton hook block on bumper	+ 3,220	- 1,730	+ 1,490
10. Rooster sheave	+ 467	- 275	+ 192

Working range



38 - 125 ft.
(11.6 - 38.1 m)

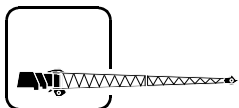

32 - 52 ft.
(9.8 - 16.0 m)

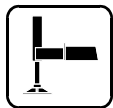

360°

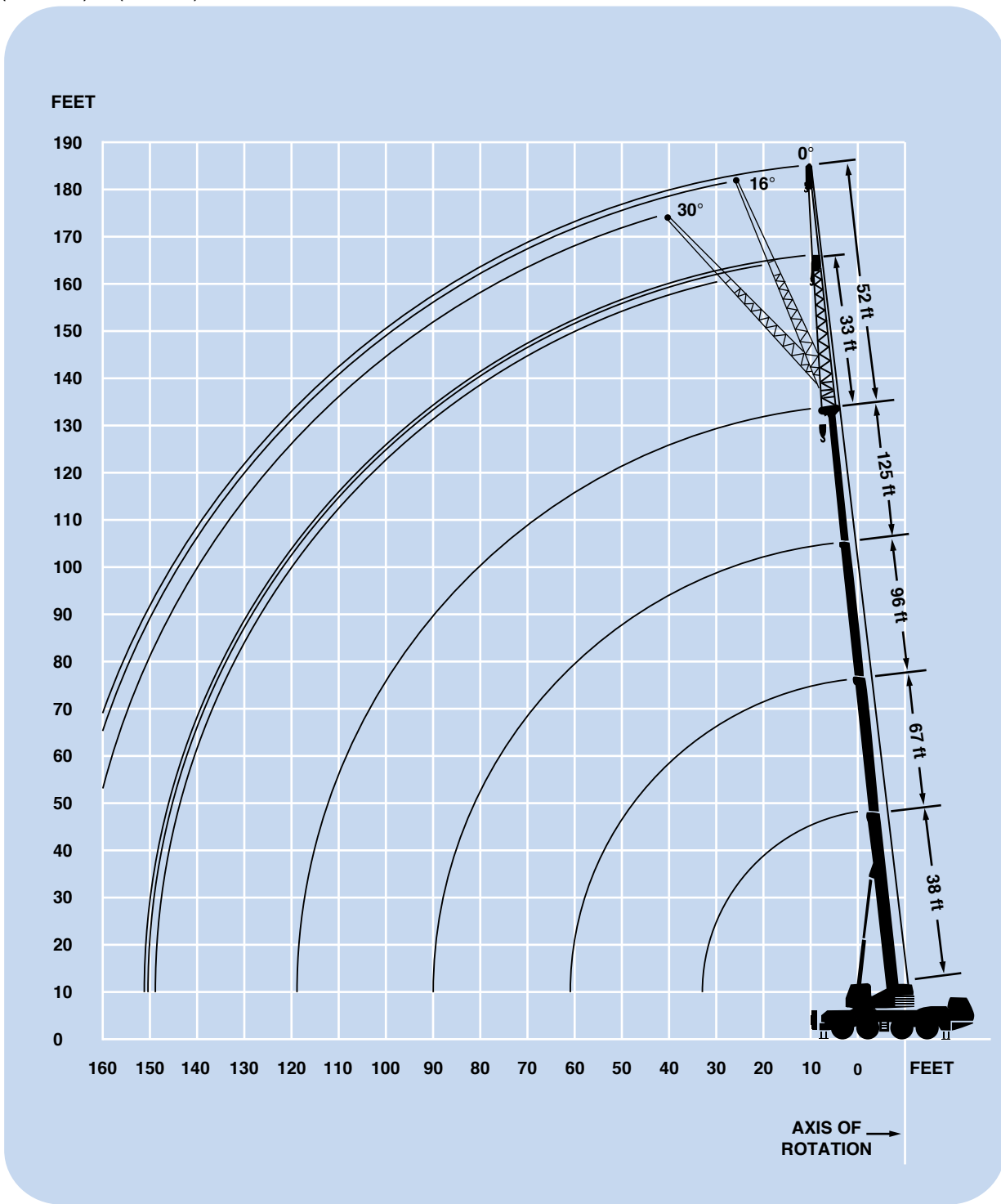

DIMENSIONS ARE FOR LARGEST GROVE FURNISHED HOOK BLOCK AND HEADACHE BALL, WITH ANTI-TWO BLOCK ACTIVATED.

Superstructure specifications

Boom

38 ft. to 125 ft. (11.6 m to 38.1 m) four-section full power boom.

Maximum tip height: 135 ft. (41 m).

Lattice Extension

Two-stage, 33 ft. to 52 ft. (10.0 m to 16.0 m) lattice extension offsettable at 16° and 30°. Stows alongside base boom section.

Maximum tip height: 187 ft. (57 m).

Boom Elevation

Single cylinder with integral holding valve provides elevation from -3.0° to 84°.

Load Moment & Anti-Two Block System

Load moment and anti-two block system with audio-visual warning and control lever lock-out. These systems provide electronic display of boom angle, length, radius, tip height, relative load moment, maximum permissible load, load indication and warning of impending two-block condition.

Cab

Full vision aluminum cab, safety glass windows, adjustable operator's seat with hydraulic suspension, engine-independent heating, instrumentation and operating controls for carrier and superstructure.

Swing

Axial piston motor with planetary gear. Holding and service brake. Swing speed variable from 0 - 2.4 RPM.

Counterweight

29,500 lbs. (13 400 kg) total. Hydraulically installed and removed.

Hydraulic System

Two separate pump circuits: two axial piston pumps with integrated infinitely variable speed (load sensing) and one fixed displacement pump for swing.

238 gallon (900 L) reservoir capacity.

All crane movements infinitely variable by hydraulic pilot circuit control levers with automatic reset to zero.

HOIST SPECIFICATIONS

Main Hoist

Axial piston fixed displacement motor with integrated planetary gear and multiple disk brake. Rope drum with special grooving.

Single line pull: 13,700 lbs.
(61 kN)

Single line speed: 394 FPM
(120 m/min)

Rope diameter: 19 mm

Rope length: 590 ft.
(180 m)

Auxiliary Hoist

Axial piston variable displacement motor with integrated planetary gear and multiple disk brake. Rope drum with special grooving.

Single line pull: 13,700 lbs.
(61 kN)

Single line speed: 394 FPM
(120 m/min)

Rope diameter: 19 mm

Rope length: 590 ft.
(180 m)

Carrier specifications

Chassis

Four-axle, all-welded torsion-resistant box-type construction of high strength steel.

Outriggers

Four hydraulically telescoping beam outriggers with vertical cylinders and outrigger pads. Independent horizontal and vertical movement control on each side of chassis. Crane level indicators at each control station.

Engine

Daimler Benz OM 442A diesel, 8 cylinders, water-cooled with turbocharger, 335 hp (250 kW) @2100 RPM. Maximum torque: 1500 Nm at 1200 RPM.

Fuel Tank Capacity

127 gallons (500 L).

Transmission

Automatic powershift transmission with 5 forward and 1 reverse gears. Two speed transfer case with longitudinal differential lock.

Drive

8 x 6 x 8

Axles

1st axle line - drive/steer.

2nd axle line - drive/steer.

3rd axle line - steer (off road only).

4th axle line - drive/steer.

Drive axles with planetary hub reduction and center mounted gearing.

Suspension

Exclusive "MEGATRAK"™ independent hydropneumatic suspension and hydraulic axle lock-out. Dual level control. Suspension range: +6.7 in. (170 mm) to -5 in. (-130 mm). Possible combination for transverse slope.

Tires

8 - 20.5R25 radials.

Steering

Dual-circuit. Automatic switch-in of standby steering pump in case of main pump failure.

Brakes

Service brake: pneumatic dual circuit acting on all wheels. Air dryer.

Auxiliary brake: hydraulic retarder integrated with automatic transmission.

Parking brake: pneumatically operated spring-loaded brake acting on 2nd and 4th axle line.

Cab

Aluminum, two-man design, safety glass, driver's seat with hydraulic suspension, engine hot water heater. Complete instrumentation and driving controls. Cab can be tilted forward by 60° for easy access to engine, transmission, hydraulic pumps, heater and batteries.

Electrical System

24 V lighting system and signals.

Generator: 28 V/55 A.

Two batteries: 12 V/170 Ah each.

Maximum Speed

46 mph (74 km/h) (with 20.5R25 tires)

Gradeability (Theoretical)

60%

Miscellaneous Standard Equipment

Hydraulic oil cooler; spare tire and wheel - 20.5R25 with carry bracket; spare parts/service manuals; hoist drum rotation indicators; flashing amber warning light on carrier cab; working light; tool kit, wheel chocks, fire extinguisher; rooster sheave; radio/cassette in carrier cab.

Optional Equipment

* 8 x 8 drive

* Hook blocks and headache balls

* 14.00 tires

* 16.00 tires

**Denotes optional equipment.*



38 - 125 ft.
(11.6 - 38.1 m)



29,500 lbs.
(13 400 kg)



27.4 x 23.6 ft.



360°



(Feet)



Pounds

	38	67	67	96	96	113	125
10	162,000						
15	126,000	85,000	43,600				
20	100,000	79,000	43,600	43,600	24,200	34,000	
25	77,000	68,000	43,600	43,600	24,200	32,400	24,200
30		55,000	43,000	38,800	24,200	29,400	24,200
35		42,200	38,400	34,800	24,200	26,800	24,200
40		33,600	34,600	31,400	24,200	24,600	24,000
45		27,600	29,400	27,200	22,400	22,600	22,200
50		23,000	24,800	22,600	20,600	20,800	20,400
55				18,800	19,200	19,000	18,600
60				15,800	17,800	17,200	17,000
65				13,200	16,600	16,600	15,400
70				11,200	15,400	12,400	13,200
75				9,400	13,600	10,600	11,400
80				7,800	12,000	9,200	9,800
85				6,600	10,600	7,800	8,600
90						6,600	7,400
95						5,600	6,400
100							5,400
105							4,600
110							4,000

All main boom charts available with 50% Outriggers.

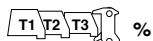

T1	0	50	0	100	0	100	100
T2	0	50	100	100	100	100	100
T3	0	0	0	0	100	60	100



38 - 125 ft.
(11.6 - 38.1 m)



16,800 lbs.
(7600 kg)



27.4 x 23.6 ft.



360°



(Feet)



Pounds

	38	67	67	96	96	113	125
10	162,000						
15	125,000	85,000	43,600				
20	96,000	79,000	43,600	43,600	24,200	34,000	
25	64,000	59,000	43,600	43,600	24,200	32,400	24,200
30		45,000	43,000	38,800	24,200	29,400	24,200
35		34,400	36,400	31,600	24,200	26,800	24,200
40		27,000	29,000	25,200	24,200	24,600	24,000
45		21,400	23,400	20,600	22,400	21,200	21,600
50		17,200	19,200	16,800	20,600	17,800	18,200
55				13,600	18,200	14,800	15,400
60				11,000	15,400	12,400	13,000
65				8,800	13,200	10,200	11,000
70				7,200	11,400	8,400	9,200
75				5,600	9,800	7,000	7,800
80				4,400	8,600	5,800	6,400
85				3,400	7,400	4,600	5,400
90						3,600	4,400
95						2,800	3,600
100							2,800
105							2,200
110							1,600

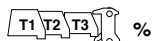

T1	0	50	0	100	0	100	100
T2	0	50	100	100	100	100	100
T3	0	0	0	0	100	60	100



38 - 125 ft.
(11.6 - 38.1 m)



4,000 lbs.
(1800 kg)



27.4 x 23.6 ft.



360°



(Feet)



Pounds

	38	67	67	96	96	113	125
10	161,000						
15	122,000	85,000	43,600				
20	80,000	64,000	43,600	43,600	24,200	34,000	
25	51,000	46,000	43,600	38,800	24,200	32,400	24,200
30		33,000	36,000	28,400	24,200	28,400	24,200
35		25,200	27,600	21,800	24,200	22,200	22,400
40		18,800	21,200	16,800	22,800	17,600	18,000
45		14,400	16,600	13,200	18,800	14,000	14,600
50		11,000	13,200	10,400	15,400	11,400	11,800
55				8,200	12,800	9,200	9,600
60				6,200	10,600	7,400	7,800
65				4,400	8,800	5,800	6,400
70				3,200	7,400	4,400	5,200
75				2,000	6,200	3,200	4,000
80				1,400	5,200	2,200	3,000
85					4,200	1,400	2,200
90							1,400

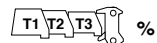

	T1	T2	T3				
T1	0	50	0	100	0	100	100
T2	0	50	100	100	100	100	100
T3	0	0	0	0	100	60	100



38 - 125 ft.
(11.6 - 38.1 m)



0 lbs.
(0 kg)



27.4 x 23.6 ft.



360°



(Feet)



Pounds

	38	67	67	96	96	113	125
10	161,000						
15	120,000	85,000	43,600				
20	74,000	59,000	43,600	43,600	24,200	34,000	
25	47,000	40,600	43,600	34,200	24,200	32,400	24,200
30		29,000	32,000	24,800	24,200	25,000	24,200
35		21,800	24,600	18,800	24,200	19,200	19,600
40		16,200	18,600	14,200	20,000	15,000	15,400
45		12,200	14,400	11,000	16,600	11,800	12,400
50		9,200	11,200	8,400	13,600	9,400	10,000
55				6,200	11,000	7,400	8,000
60				4,600	9,200	5,600	6,200
65				3,200	7,400	4,200	5,000
70				1,800	6,200	3,000	3,800
75					5,000	2,000	2,800
80					4,200		1,800
85					3,200		

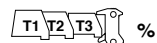

	T1	T2	T3				
T1	0	50	0	100	0	100	100
T2	0	50	100	100	100	100	100
T3	0	0	0	0	100	60	100



110.5 - 125 ft.
(33.7 - 38.1 m)

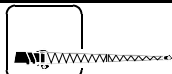

32.8 - 52 ft
(10 - 16.0 m)



29,500 lbs.
(13 400 kg)



27.4 x 23.6 ft.



360°



(Feet)	110.5' Main Boom			125' Main Boom		
	0° - 32.8'	16° - 32.8'	30° - 32.8'	0° - 32.8'	16° - 32.8'	30° - 32.8'
30	17,400	12,200		11,200		
35	16,400	12,200	8,800	11,200	8,800	6,600
40	15,400	12,000	8,800	11,200	8,800	6,600
45	14,400	11,400	8,800	11,200	8,800	6,600
50	13,600	11,000	8,800	11,000	8,400	6,400
55	12,600	10,400	8,600	10,200	8,000	6,000
60	11,800	10,200	8,200	9,600	7,600	5,800
65	11,000	9,800	7,800	9,000	7,400	5,600
70	10,200	9,400	7,400	8,400	7,000	5,400
75	9,600	8,800	7,200	7,800	6,600	5,200
80	9,000	8,400	6,800	7,400	6,400	5,200
85	8,400	7,800	6,600	7,000	6,000	5,000
90	7,800	7,200	6,400	6,600	5,800	5,000
95	6,600	6,600	6,200	6,200	5,600	4,800
100	5,800	6,000	6,000	6,000	5,400	4,800
105	5,000	5,200	5,400	5,200	5,000	4,600
110	4,200	4,400	4,600	4,600	4,800	4,600
115	3,400	3,800	3,800	3,800	4,200	4,400
120	2,800	3,000	3,200	3,200	3,600	3,800
125	2,400	2,400	2,400	2,600	3,000	3,000
130	1,800	1,800	1,800	2,200	2,400	2,400
135				1,800	1,800	2,000
140						
145						
150						

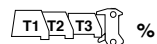

T1	100	100	100	100	100	100
T2	100	100	100	100	100	100
T3	50	50	50	100	100	100



110.5 - 125 ft.
(33.7 - 38.1 m)

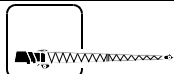

32.8 - 52 ft
(10 - 16.0 m)



29,500 lbs.
(13 400 kg)



27.4 x 23.6 ft.



360°



Pounds

(Feet)	110.5' Main Boom			125' Main Boom		
	0° - 52'	16° - 52"	30° - 52"	0° - 52"	16° - 52"	30° - 52"
30	8,400					
35	8,400	8,400		6,000		
40	8,400	8,400		6,000	6,000	
45	8,400	8,400	5,000	6,000	6,000	
50	8,000	7,800	5,000	6,000	6,000	4,400
55	7,800	7,400	5,000	6,000	5,800	4,400
60	7,400	7,000	4,800	6,000	5,600	4,400
65	7,200	6,600	4,600	5,800	5,400	4,200
70	6,800	6,200	4,400	5,600	5,200	4,000
75	6,600	5,800	4,200	5,200	5,000	4,000
80	6,400	5,400	4,000	4,800	4,800	3,800
85	6,200	5,200	3,800	4,600	4,600	3,800
90	6,000	5,000	3,600	4,400	4,400	3,600
95	5,800	4,800	3,600	4,200	4,000	3,600
100	5,800	4,800	3,400	4,000	3,800	3,600
105	5,600	4,800	3,200	4,000	3,600	3,400
110	5,000	4,600	3,000	3,800	3,400	3,400
115	4,200	4,600	2,800	3,800	3,200	3,400
120	3,600	4,200	2,800	3,600	3,200	3,200
125	3,000	3,600	2,600	3,400	3,000	3,200
130	2,600	3,000	2,400	2,800	3,000	3,200
135	2,000	2,400	2,400	2,400	2,800	3,000
140	1,600	2,000	2,000	1,800	2,200	2,400
145					1,800	2,000
150					1,400	1,400

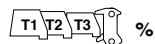

T1	100	100	100	100	100	100
T2	100	100	100	100	100	100
T3	50	50	50	100	100	100



110.5 - 125 ft.
(33.7 - 38.1 m)

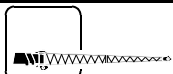

32.8 - 52 ft
(10 - 16.0 m)



16,800 lbs.
(7600 kg)



27.4 x 23.6 ft.



360°



(Feet)	110.5' Main Boom			125' Main Boom		
	0° - 32.8'	16° - 32.8'	30° - 32.8'	0° - 32.8'	16° - 32.8'	30° - 32.8'
30	17,400	12,200		11,200		
35	16,400	12,200	8,800	11,200	8,800	6,600
40	15,400	12,000	8,800	11,200	8,800	6,600
45	14,400	11,400	8,800	11,200	8,800	6,600
50	13,600	11,000	8,800	11,000	8,400	6,400
55	12,600	10,400	8,600	10,200	8,000	6,000
60	11,800	10,200	8,200	9,600	7,600	5,800
65	11,000	9,800	7,800	9,000	7,400	5,600
70	9,600	9,400	7,400	8,400	7,000	5,400
75	8,200	8,800	7,200	7,800	6,600	5,200
80	6,800	7,600	6,800	7,200	6,400	5,200
85	5,800	6,400	6,600	6,200	6,000	5,000
90	4,800	5,200	5,600	5,200	5,800	5,000
95	3,800	4,400	4,600	4,200	4,800	4,800
100	3,000	3,600	3,800	3,400	4,000	4,200
105	2,400	2,800	3,000	2,800	3,200	3,400
110	1,800	2,200	2,200	2,200	2,600	2,800
115		1,400	1,600	1,600	2,000	2,200
120					1,400	1,600
125						
130						
135						
140						
%						
T1	100	100	100	100	100	100
T2	100	100	100	100	100	100
T3	50	50	50	100	100	100



110.5 - 125 ft.
(33.7 - 38.1 m)

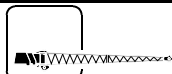

32.8 - 52 ft
(10 - 16.0 m)



16,800 lbs.
(7600 kg)



27.4 x 23.6 ft.





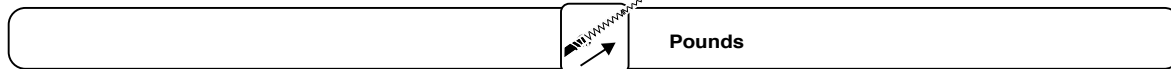

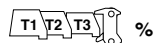

360°















(Feet)	110.5' Main Boom			125' Main Boom		
	0° - 52'	16° - 52'	30° - 52'	0° - 52'	16° - 52'	30° - 52'
30	8,400					
35	8,400	8,400		6,000		
40	8,400	8,400		6,000	6,000	
45	8,400	8,400	5,000	6,000	6,000	
50	8,000	7,800	5,000	6,000	6,000	4,400
55	7,800	7,400	5,000	6,000	5,800	4,400
60	7,400	7,000	4,800	6,000	5,600	4,400
65	7,200	6,600	4,600	5,800	5,400	4,200
70	6,800	6,200	4,400	5,600	5,200	4,000
75	6,600	5,800	4,200	5,200	5,000	4,000
80	6,400	5,400	4,000	4,800	4,800	3,800
85	6,200	5,200	3,800	4,600	4,600	3,800
90	5,600	5,000	3,600	4,400	4,400	3,600
95	4,800	4,800	3,600	4,200	4,000	3,600
100	4,000	4,800	3,400	4,000	3,800	3,600
105	3,200	4,000	3,200	3,400	3,600	3,400
110	2,600	3,200	3,000	2,800	3,400	3,400
115	2,000	2,600	2,800	2,200	3,000	3,400
120	1,600	2,000	2,400	1,800	2,400	2,800
125		1,600	1,800	1,200	1,800	2,200
130			1,200		1,400	1,600
135						
140						



T1	100	100	100	100	100	100
T2	100	100	100	100	100	100
T3	50	50	50	100	100	100

			
38 - 67 ft. (11.6 - 20.4 m)	29,500 lbs. (13 400 kg)		Over Rear
	 Pounds		
(Feet)	38	67	
10	38,200		
15	28,000	28,800	
20	21,000	22,000	
25	16,400	17,200	
30		13,600	
35		10,800	
40		8,800	
45		7,000	
50		5,400	

			
38 - 67 ft. (11.6 - 20.4 m)	16,800 lbs. (7600 kg)		Over Rear
	 Pounds		
(Feet)	38	67	
10	37,800		
15	27,600	28,400	
20	20,800	21,600	
25	15,400	16,400	
30		12,000	
35		8,800	
40		6,400	
45		4,800	
50		3,400	

			
38 - 67 ft. (11.6 - 20.4 m)	4,000 lbs. (1800 kg)		Over Rear
	 Pounds		
(Feet)	38	67	
10	37,200		
15	25,600	26,800	
20	16,200	17,200	
25	10,600	11,600	
30		7,600	
35		5,000	
40		3,400	
45		2,200	

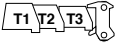
	%	
T1	0	0
T2	0	100
T3	0	0





































Rated lifting capacities

Important Notes:

Warning: THIS CHART IS ONLY A GUIDE.
The notes below are for illustration only and should not be relied upon to operate the crane. The individual crane's load chart, operating instructions and other instruction plates must be read and understood prior to operating the crane.

1. All rated loads have been tested to and meet minimum requirements of SAEJ1063 - Cantilevered Boom Crane Structures - Method of Test, and do not exceed 85% of the tipping load on outriggers as determined by SAEJ765 Crane Stability Test Code.
2. Capacities given do not include the weight of hook blocks, slings, auxiliary lifting equipment and load handling devices. Their weights must be added to the load to be lifted. When more than minimum required reeving is used, the additional rope weight shall be considered part of the load.
3. All capacities are for crane on firm, level surface. It may be necessary to have structural supports under the outrigger floats or tires to spread the load to a larger bearing surface.
4. When either boom length or radius or both are between values listed, the smallest load shown at either the next larger radius or boom length shall be used.
5. For outrigger operation, ALL outriggers shall be properly extended with tires raised free of ground before raising the boom or lifting loads.

Symbols Glossary

	Frame		Steering
	Outriggers		Transmission
	Outrigger Controls		Axles
	Engine		Brakes
	Fuel Tank Capacity		Tires
	Electrical System		Suspension
	Drive		Rotation
	Lights		Boom Elevation
	Cab		Swing
	Boom		Counterweight
	Fixed Swingaway		Oil
	Tele-Swingaway		Hydraulic System
	Jib		Hoist
	Boom Nose		Radius
	Boom Extension		Boom Length
	Speed		Hookblock
	Grade		Gear
	Lattice Extension		Luffing Jib

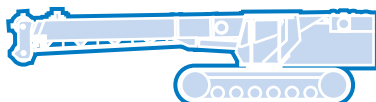
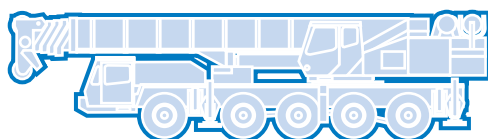
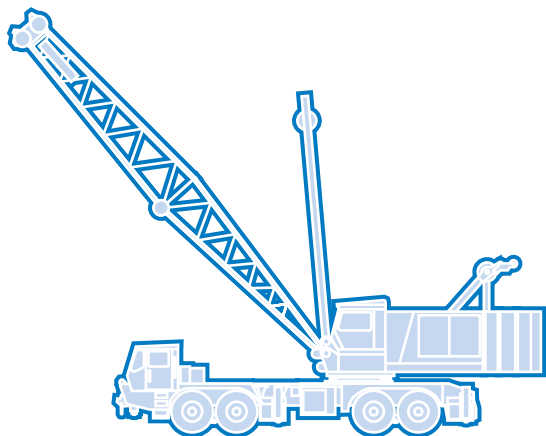

Grove Worldwide – World Headquarters

Grove North America
1565 Buchanan Trail East
P.O. Box 21
Shady Grove, Pennsylvania 17256, USA
Tel: [Int + 1] (717) 597-8121
Fax: [Int + 1] (717) 597-4062
Western Hemisphere, Asia/Pacific

Grove Europe Limited*
Sunderland SR4 6TT, England
Tel: [Int + 44] 191 565-6281
Fax: [Int + 44] 191 564-0442
Europe, Africa, Middle East

Grove Europe Limited*
P.O. Box No. 268
4A Kimber Road
Abingdon, Oxfordshire, OX14 1SG
Tel: [Int + 44] 1235 55-3184
Fax: [Int + 44] 1235 55-3218
*Grove Europe Limited, Registered in England,
Number 1845128, Registered office, Crown Works,
Pallion, Sunderland, Tyne & Wear, England SR4 6TT

Deutsche Grove GmbH
Sales and Service
Helmholtzstrasse 12, Postfach 5026
D-40750 Langenfeld, Germany
Tel: [Int + 49] (2173) 8909-0
Fax: [Int + 49] (2173) 8909-30

Wilhelmshaven Works
Industriegelände West, Postfach 1853
D-26358 Wilhelmshaven, Germany
Tel: [Int + 49] (4421) 294-0
Fax: [Int + 49] (4421) 294-301

Grove France SA
16, chaussée Jules-César, 95520 OSNY
B.P. 203, 95523 CERGY-PONTOISE CEDEX
France
Tel: [Int + 33] (1) 30313150
Int: [Int + 33] (1) 30386085

Grove Asia/Pacific - Regional Office
171 Chin Swee Road
#06-01 San Centre
Singapore 0316
Tel: [Int + 65] 536-6112
Fax: [Int + 65] 536-6119
Asia/Pacific, Near East

Grove China - Representative Office
Beijing Hotel Room 6074
No. 33 East Chang An Avenue
Beijing, 100004, China
Tel: [Int + 86] (10) 513-7766
Fax: [Int + 86] (10) 513-7307

Grove Product Support
Western Hemisphere, Asia/Pacific
1086 Wayne Avenue
Chambersburg, Pennsylvania USA
Tel: [Int + 1] (717) 263-5100
Fax: [Int + 1] (717) 267-0404

Europe, Africa, Middle East
Sunderland SR4 6TT, England
Tel: [Int + 44] 191 565-6281
Parts Fax: [Int + 44] 191 510-9242
Service Fax: [Int + 44] 191 510-9560

<http://www.grovetworldwide.com>

Constant improvement and engineering progress make it necessary that we reserve the right to make specification, equipment, and price changes without notice. Illustrations shown may include optional equipment and accessories and may not include all standard equipment.

Distributed By: